

# MY Titanic inFORMATION BOOKlet

Name: \_\_\_\_\_

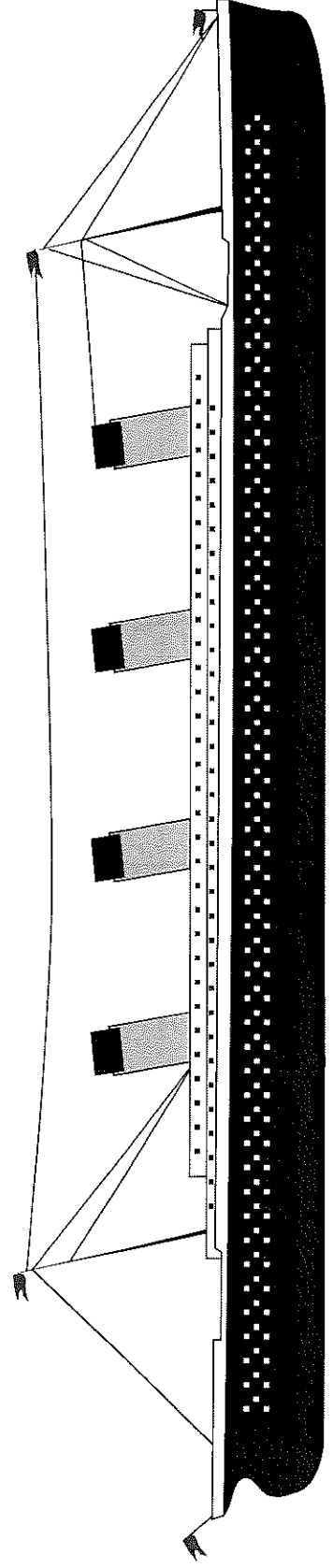

# Titanic Stats

OFFICIAL NAME: \_\_\_\_\_

CAPTAIN: \_\_\_\_\_

YEARS TO BUILD: \_\_\_\_\_

NUMBER OF WORKERS: \_\_\_\_\_

COST THEN: \_\_\_\_\_ COST NOW: \_\_\_\_\_

HEIGHT: \_\_\_\_\_ LENGTH: \_\_\_\_\_ WIDTH: \_\_\_\_\_

WEIGHT: (SHIP) \_\_\_\_\_ (RUDDER) \_\_\_\_\_

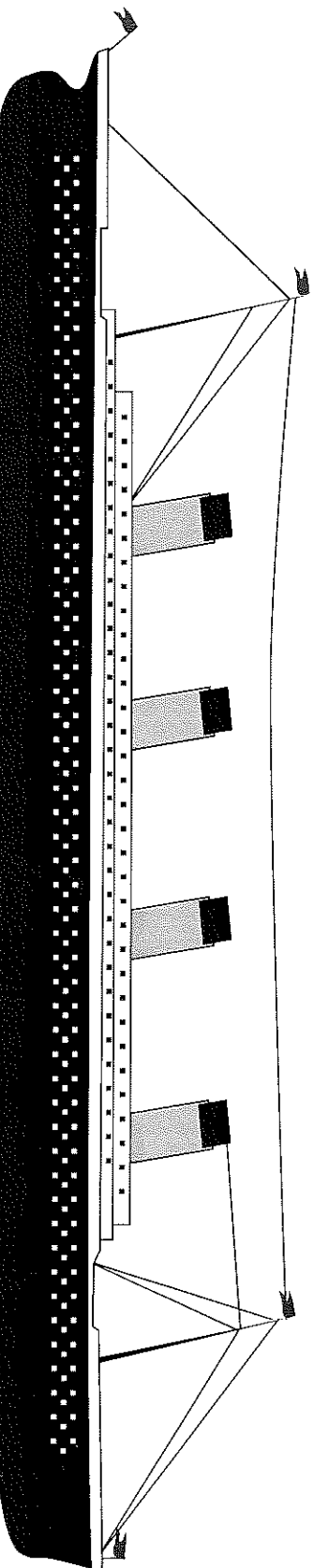

# What was on board?

Pounds of fresh meat: \_\_\_\_\_

Pieces of fruit: \_\_\_\_\_

Pieces of cookware, glassware &

Cutlery: \_\_\_\_\_

People: \_\_\_\_\_ (passengers: \_\_\_\_\_ crew: \_\_\_\_\_)

Bags of mail: \_\_\_\_\_

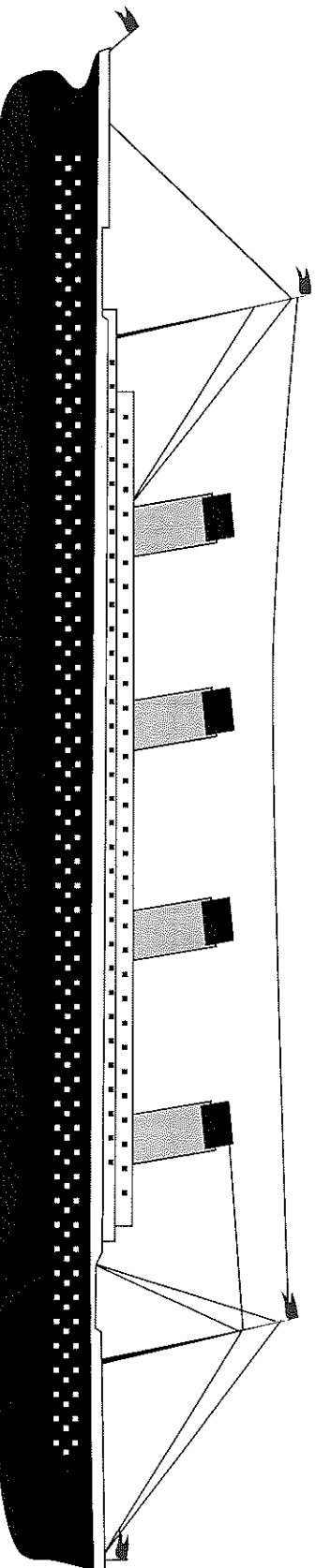

# iceberg Straight Ahead!

Distance Titanic Sailed: \_\_\_\_\_

Distance From Land When it Sank: \_\_\_\_\_

Distance of Nearest Vessel: \_\_\_\_\_

Name of Nearest Vessel: \_\_\_\_\_

Speed at time of impact: \_\_\_\_\_

Number of iceberg warnings received that day: \_\_\_\_\_

Water temperature that day: \_\_\_\_\_

Average time of survival in water that cold: \_\_\_\_\_

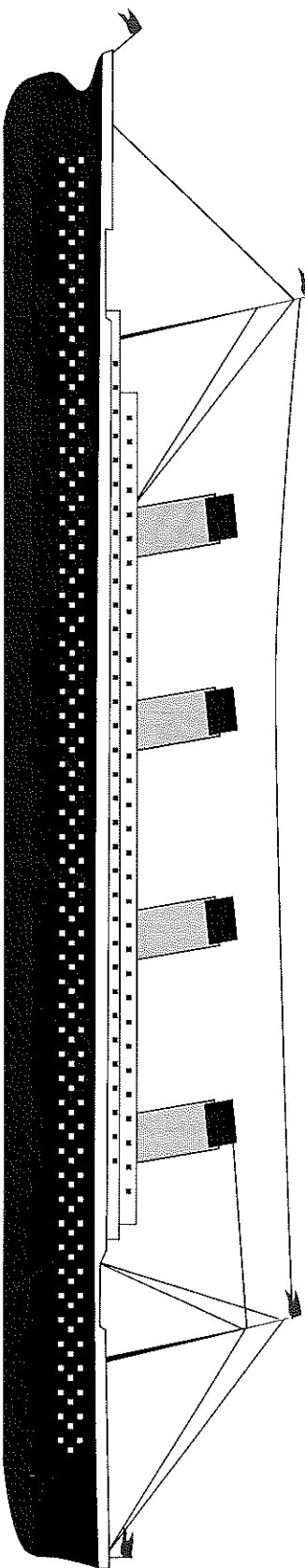

# SURVIVAL

NUMBER OF LIFEBOATS: \_\_\_\_\_

NUMBER OF PEOPLE THAT COULD FIT INTO THE LIFEBOATS: \_\_\_\_\_

NUMBER OF PEOPLE THAT MADE IT INTO A LIFE BOAT: \_\_\_\_\_

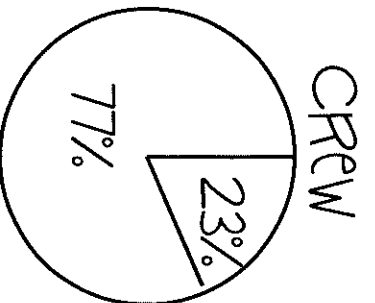
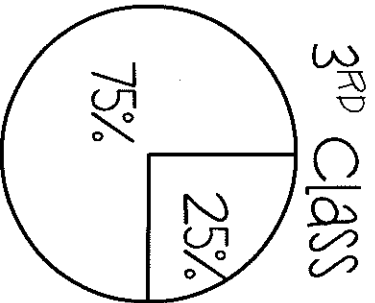
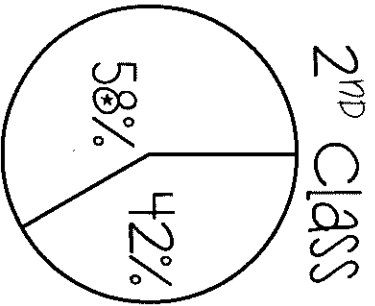
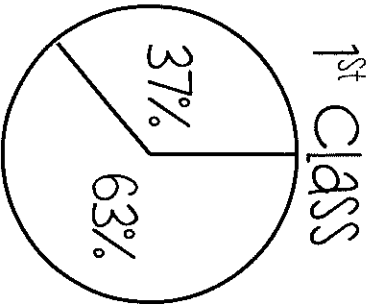

SURVIVED  PERISHED

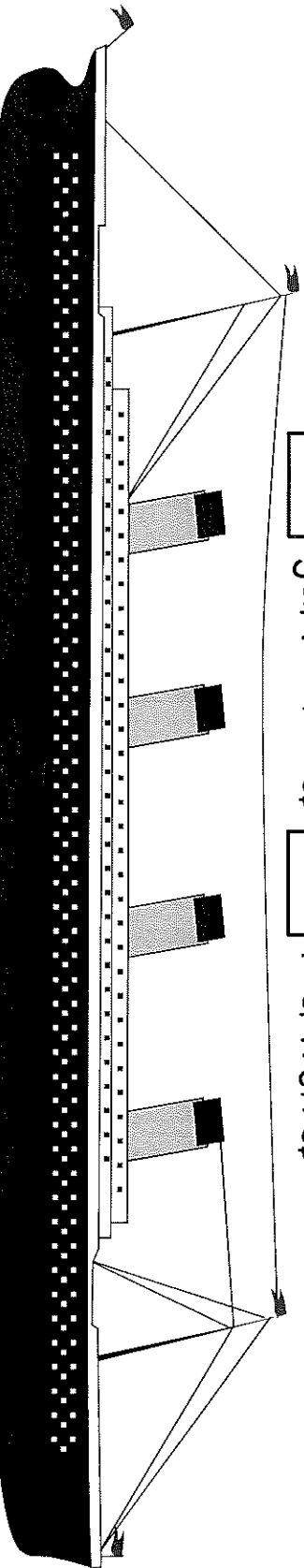

# Timeline: Birth of the Titanic

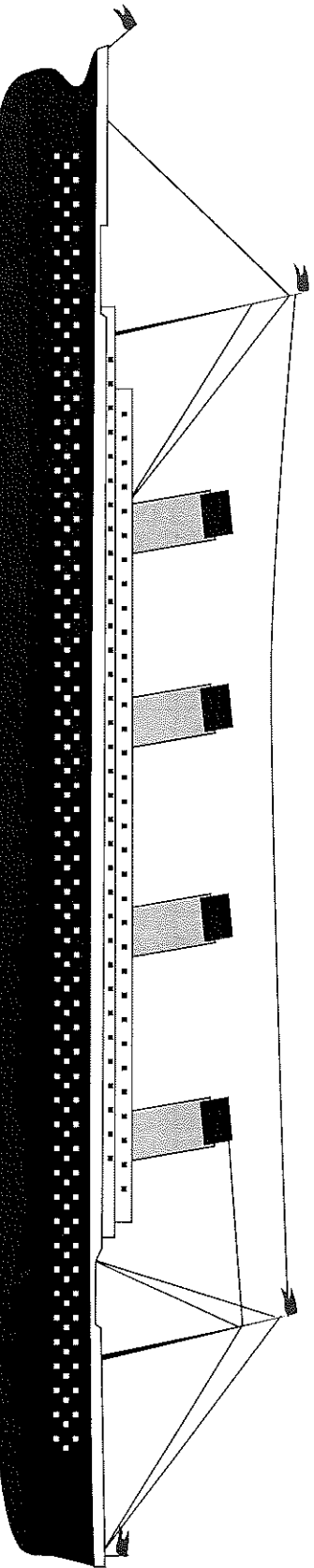
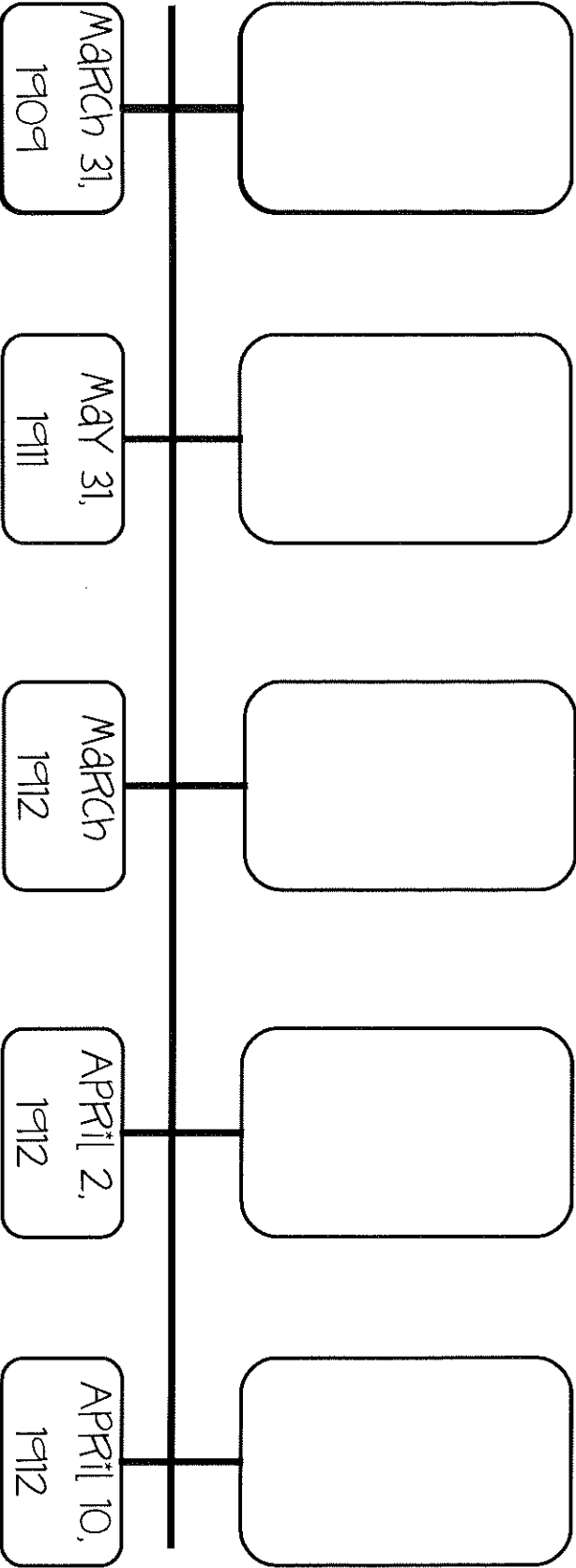

# Timeline: The Disaster (PART 1)

APRIL 11-13  
1912

APRIL 14,  
1912  
9:00 a. m.

APRIL 14,  
1912  
7:30 p. m.

APRIL 14,  
1912  
9:40 p. m.

APRIL 14,  
1912  
10:50 p. m.

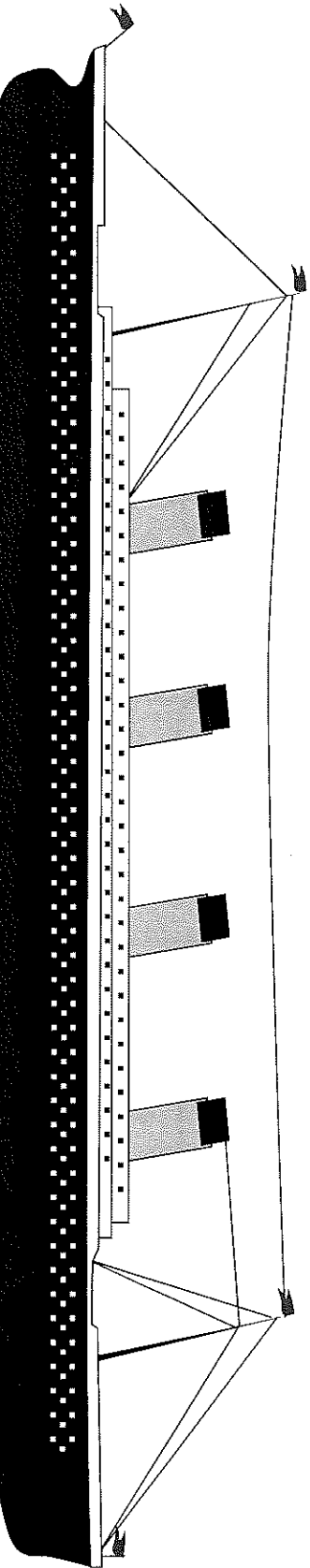

# Timeline: The Disaster (PART 2)

APRIL 14,  
1912  
11:40 P. M.

APRIL 15,  
1912  
12:15 A. M.

APRIL 15,  
1912  
12:45 A. M.

APRIL 15,  
1912  
1:15 A. M.

APRIL 15,  
1912  
2:05 A. M.

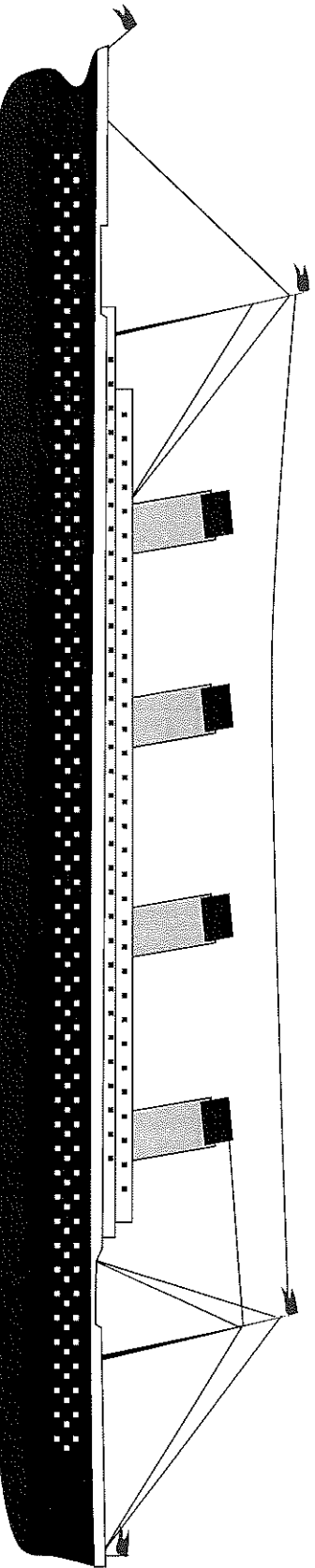



# Timeline: The Disaster (part 3)

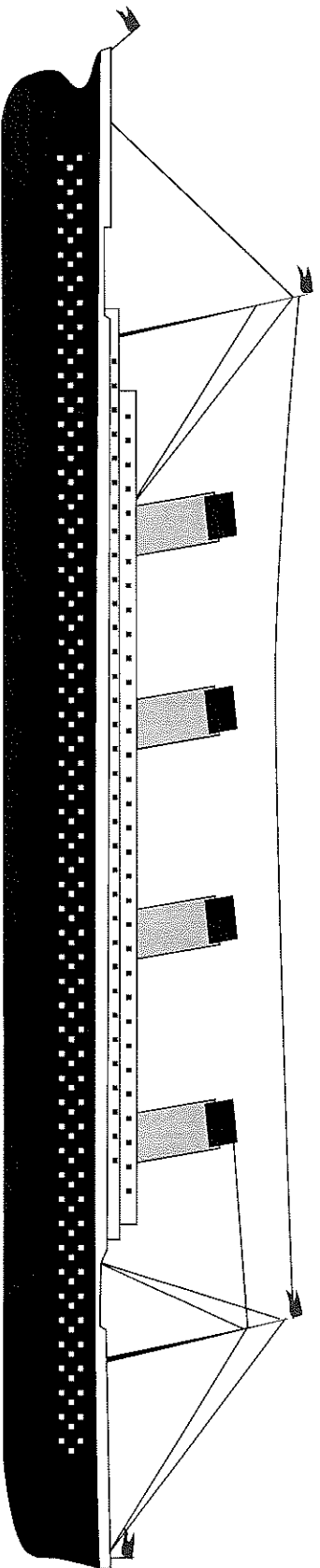
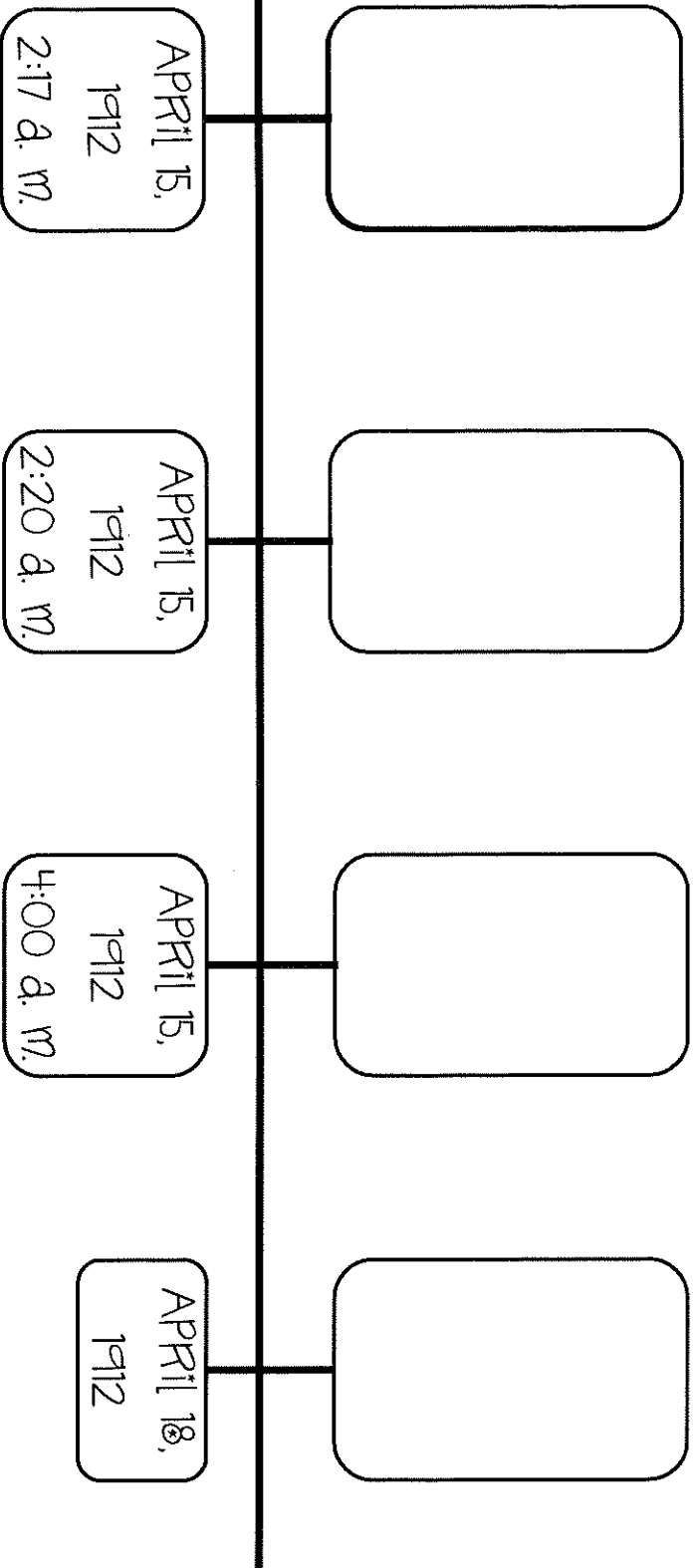

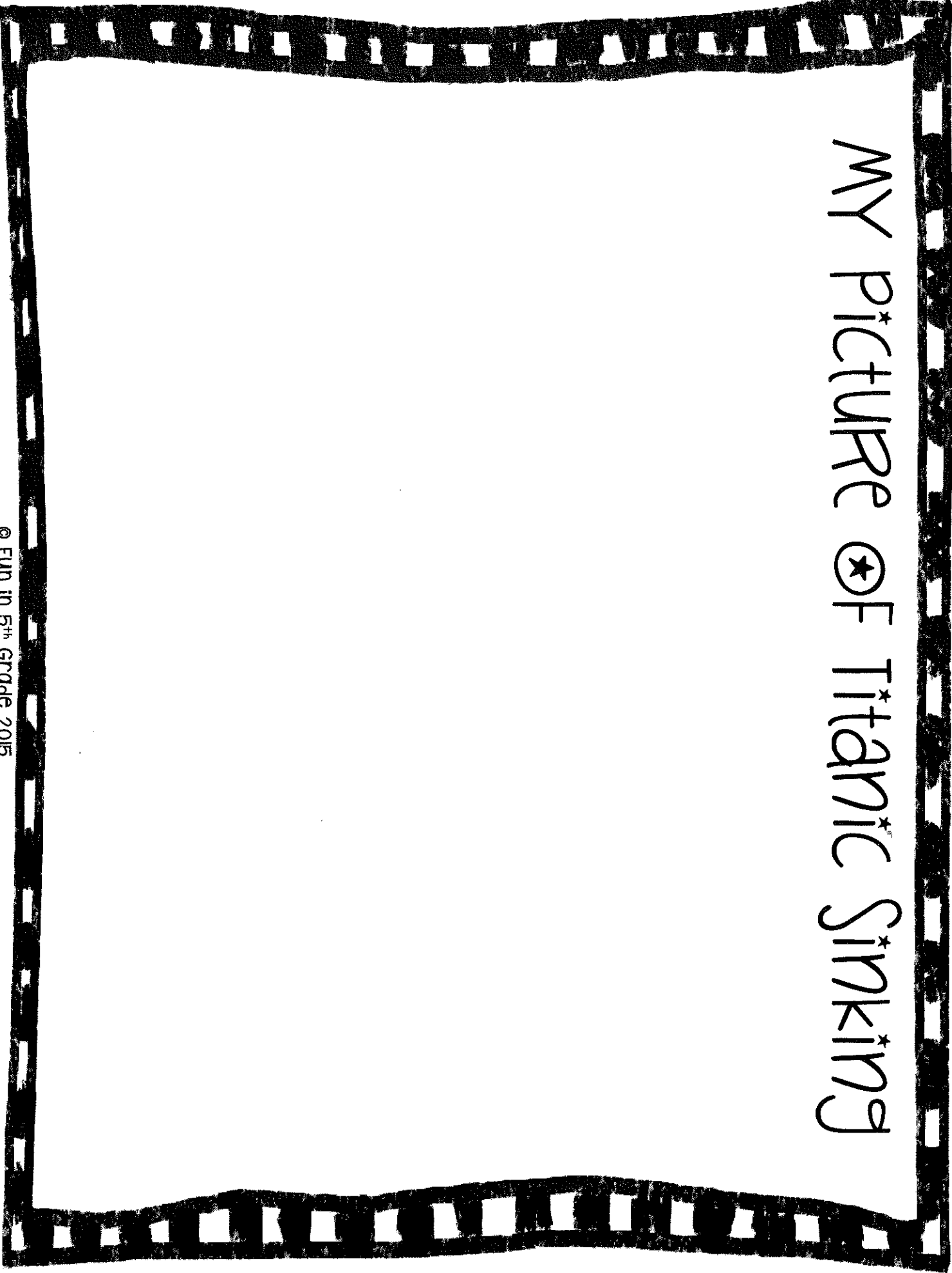

# MY PICTURE OF TITANIC SINKING

# TITANIC FUN FACTS

1. \_\_\_\_\_
2. \_\_\_\_\_
3. \_\_\_\_\_
4. \_\_\_\_\_
5. \_\_\_\_\_
6. \_\_\_\_\_
7. \_\_\_\_\_
8. \_\_\_\_\_
9. \_\_\_\_\_
10. \_\_\_\_\_

