

Hi! Work out the angles on a straight line shown below.

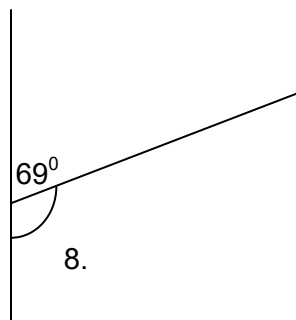

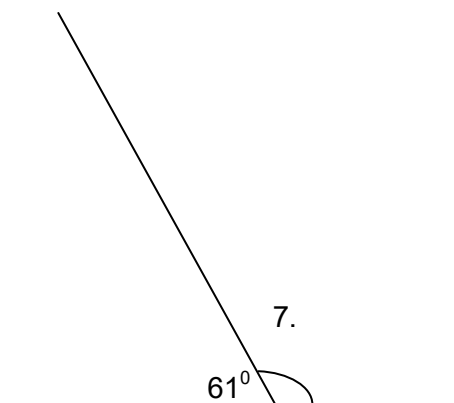

Hi! Work out the angles on a straight line shown below.

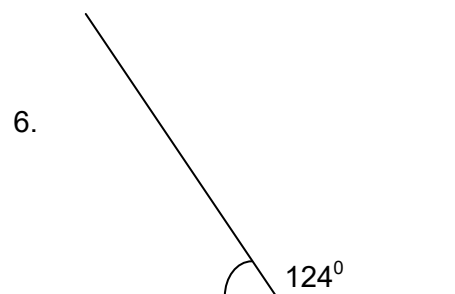
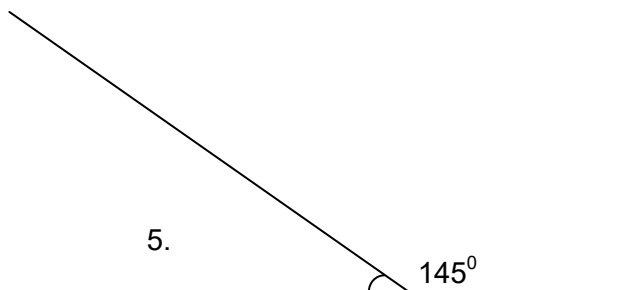
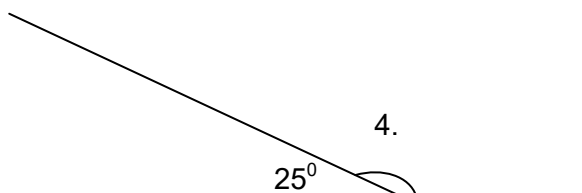
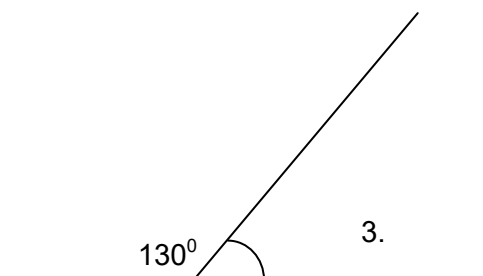
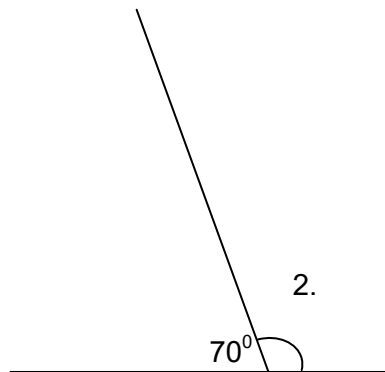
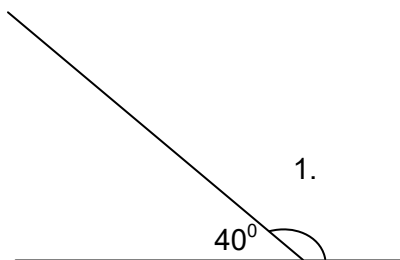
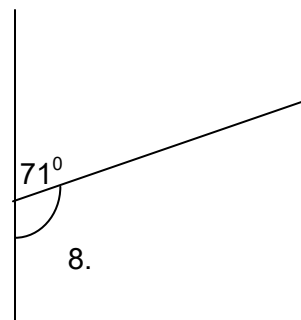
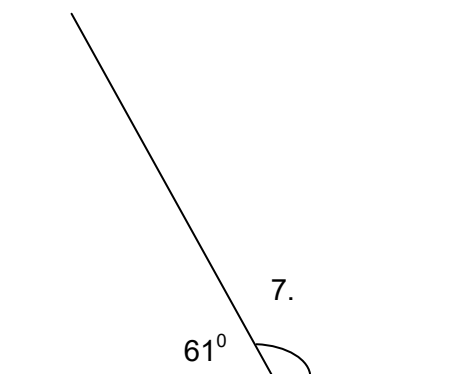
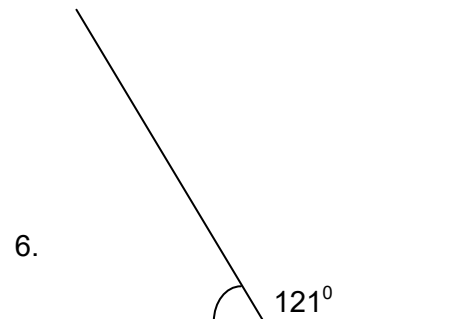
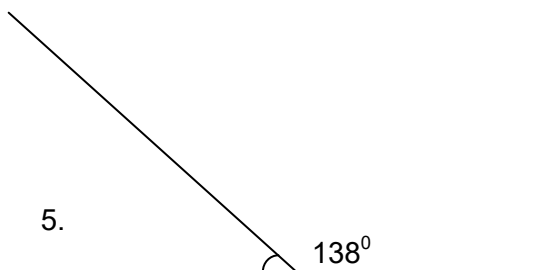
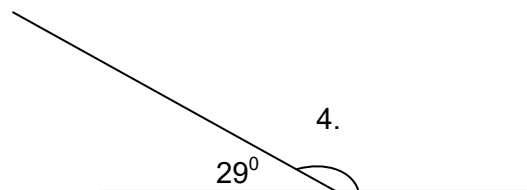
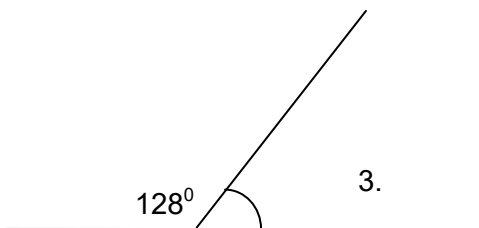
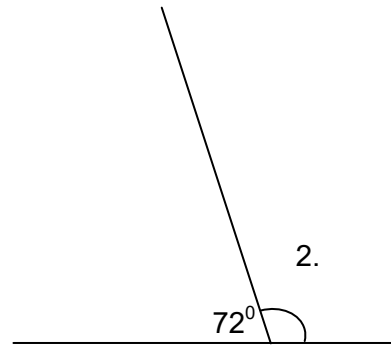
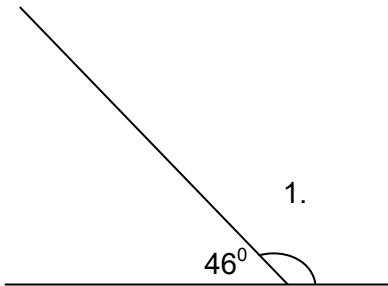



Hi! Work out the angles on a straight line shown below.

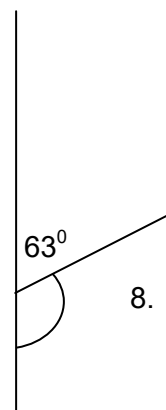
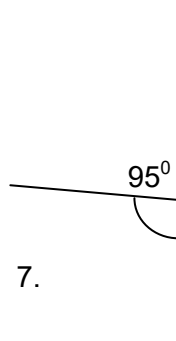
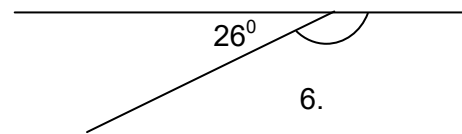
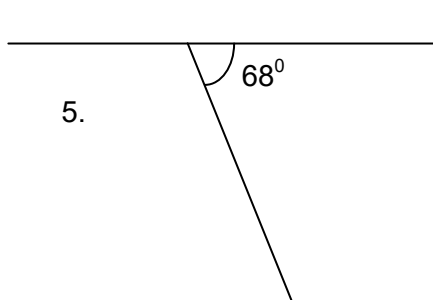
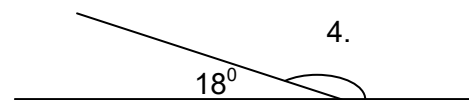
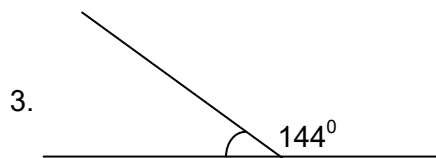
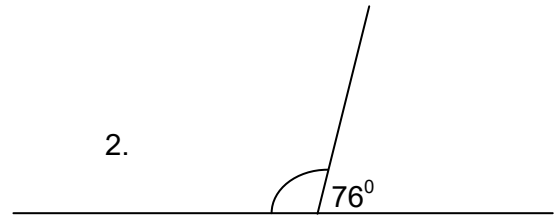
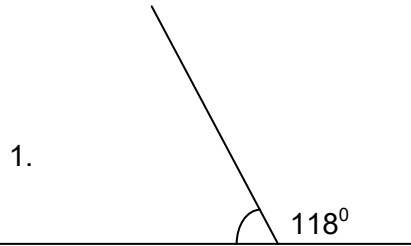

9. Draw an angle larger than 90°



Hi! Work out the angles on a straight line shown below.

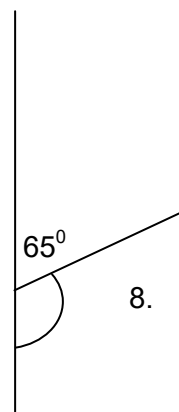
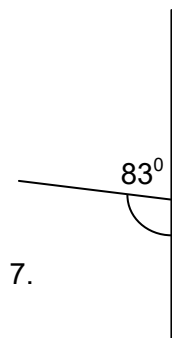
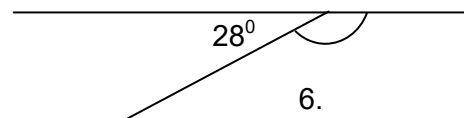
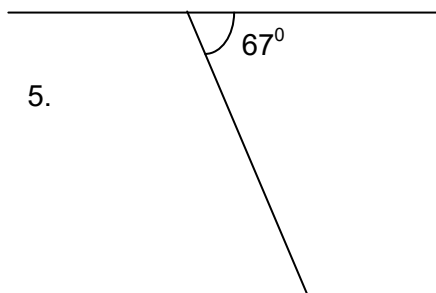
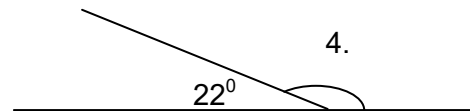
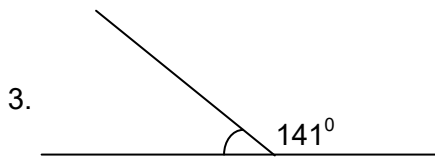
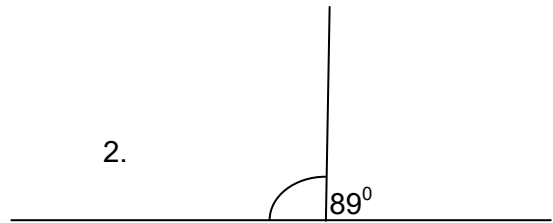
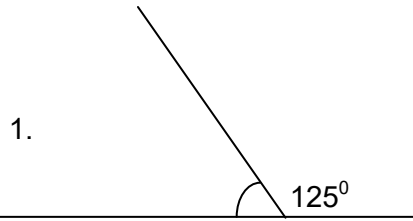

9. Draw an angle less than 90°

Name:

Answers

Page 1

1. 140° 2. 110° 3. 50° 4. 155°
5. 35° 6. 56° 7. 119° 8. 111°

Page 2

1. 134° 2. 108° 3. 52° 4. 151°
5. 42° 6. 59° 7. 119° 8. 109°

Page 3

1. 62° 2. 104° 3. 36° 4. 162°
5. 112° 6. 154° 7. 85° 8. 117°

9. an angle larger than 90° drawn.

Page 4

1. 55° 2. 91° 3. 39° 4. 158°
5. 113° 6. 152° 7. 97° 8. 115°

9. an angle less than than 90° drawn.